

## User manual



**Husky**



**Mini**



**Midi**



**Maxi**



**Maxi Comfort**



**Viktoria**



**Viktor**

Van Raam  
Guldenweg 23  
7051 HT Varsseveld, The Netherlands

☎ +31 (0)315 – 25 73 70

✉ [info@vanraam.com](mailto:info@vanraam.com)

🌐 [www.vanraam.com](http://www.vanraam.com)

Version 24.07



# Table of contents

Manufacturer contact details.....	3
Conformity Europe (CE).....	3
Conformity UK (UKCA).....	3
Introduction.....	4
Delivery.....	4
Indication.....	5
Intended usage.....	5
Safety measures.....	6
Adjustment of the tricycle.....	8
Before the first use.....	10
Electro system Silent.....	16
Van Raam e-bike app.....	29
Accessories.....	30
Technical specifications.....	36
Maintenance and adjustments to be done by owner.....	37
Repairs and maintenance to be done by dealer.....	38
Adjustments to be done by dealer.....	39
Disposal.....	40
Handover/sale to a new owner.....	40
Guarantee.....	41
Frame number.....	42
Maintenance recommendation.....	44
Service plan.....	46
Delivery and service form.....	51

## Manufacturer contact details

Van Raam  
Guldenweg 23  
7051 HT Varsseveld, The Netherlands

☎ +31 (0)315 – 25 73 70

✉ [info@vanraam.com](mailto:info@vanraam.com)

🌐 [www.vanraam.com](http://www.vanraam.com)

## Conformity Europe (CE)

Van Raam Reha Bikes B.V., as manufacturer, declares that the Husky / Mini / Midi / Maxi / Maxi Comfort / Viktoria / Viktor, as described in this user manual, is manufactured in accordance with Regulation (EU) 2017/745, risk class 1. The tricycle supplied with the Silent electrical system also complies with Directive 2006/42/EC including the applicable parts of EMC Directive 2014/30/EU and the NEN-EN 15194:2017 Bicycles - Electric supporting bicycles - EPAC Bicycles - part 4.2 Electrical requirements. The signed declaration of conformity can be found on the Van Raam website.

## Conformity UK (UKCA)

Van Raam Reha Bikes B.V. as manufacturer declares that the Husky / Mini / Midi / Maxi / Maxi Comfort / Viktoria / Viktor, as described in this user manual, is manufactured in accordance with the "Essential Requirements of Medical Devices Regulation 2002" (UK MDR 2002 Class 1 Medical Devices). The tricycle supplied with the Silent electrical system also complies with the "Machinery (Safety) Directive SI 2008/1597" including the applicable parts of "Electro Magnetic Compatibility Regulations SI 2016/1091" and the NEN-EN 15194:2017 Bicycles - Electric support bicycles - EPAC Bicycles - part 4.2 Electrical requirements. The tricycle is provided with UKCA label according to "EU Exit Regulations 2020/1478". The signed declaration of conformity can be found on the Van Raam website.

## Introduction

This user manual provides important and necessary information about the use of your tricycle. We ask you to read this manual thoroughly before using the tricycle. Always follow the instructions as provided in this user manual and keep the manual carefully. The most current version of the user manual can be found on the product page of the bicycle on the website [www.vanraam.com](http://www.vanraam.com).



**READ CAREFULLY**

All safety and user aspects have to be made clear to children and to people with limited powers of perception by a responsible and supervising person.

## Delivery

Your delivery should include the following:

- Tricycle with packaging
- User manual(s)
- Possible Smart-battery including card with 5-digit code (depending on options)
- Possible chargers (depending on options)
- Spare keys

Check the delivery immediately after receiving it. In case of damage or incomplete delivery we ask you to contact your dealer immediately. Upon delivery you should fill out the form "Form service, maintenance, modifications and warranty claims" in the back of this manual.

## Indication

Children or adults who cannot use tricycles or vehicles due to their handicap, are able to ride these tricycles. The tricycles can be used by children or adults with neuro-muscular disorders such as paralysis of the brain and muscular dystrophy. This also applies to people suffering from co-ordination problems, loss of balance and limited natural movements. If necessary, supervision may be desirable.

## Intended usage

The tricycles are designed for normal use on level and solid ground. In general, tricycle caution should always be observed when using the tricycle. Moreover, the safety instructions as described in this manual should be explicitly followed. Local traffic laws and regulations should also be observed.

The tricycles is meant for one person. The driver should be independently mobile and may not have any serious visual or other impairments, which prevent responsible participation in traffic. The maximum user weight and luggage load (to be found in the chapter **'Technical Specifications'**) may not be exceeded.

The manufacturer is not responsible for any damage or injury caused as a result of or during the course of any other type of use.

## Safety measures

- Ensure the tricycle is in good condition each time before using it. Check before **each** ride that the brakes are in order. Check the lighting and make sure there is enough tyre pressure.
- Regularly check if the wheels, the handlebars and the saddle are properly fixed and also whether all screw joints are tight.
- Only use the tricycle on a **solid and level surface**.
- It is not recommended to cycle on a slope steeper than 10%, this carries an increased risk.
- It is advised to **drive slowly on slopes**, especially when riding backwards. When braking while riding backwards, it is advised to use a dosed braking force. When doing so, avoid the bike losing contact with the road.
- In the case you stand still on a slope or ramp, proceed to drive off slowly. While driving off you can lean forwards to prevent the front wheel being lifted.
- Avoid riding on steep slopes when your bike is fitted with one of the following accessories on the rear of the bike: Walking Holder bracket, wheelchair holder, child seats, or loaded baskets. In these cases the front wheel of your bike may lose contact with the road more easily.
- Make sure that wide trousers or loose hanging clothing don't get caught in the chain, spokes or pedals.
- Do not use a pressure washer or a steam cleaner for the cleaning of the tricycle.
- Block the tricycle to stop it from moving when you are getting on or off the tricycle. Do this by using the parking brake and holding the tricycle.
- Always lock the tricycle when leaving it unattended.
- Make sure that you do not reach a dangerous speed when driving downhill and entering tunnels. Brake in time and bike at a moderate speed.
- Always drive perpendicularly and at low speed off the curb or speed bump.
- In case of pregnancy, extra care is required owing to a higher risk of injury.
- Do not leave the tricycle in direct sunlight: the temperature of some parts could exceed 41°C resulting in possible burns to the skin.
- If your tricycle is equipped with the Silent electric motor system, make sure that you get used to riding with the electric support engaged. Be careful when you turn on the electric support system and make sure you don't get startled by unexpected behaviour because you turned on the electric support.

- Practice the reverse function! Please be careful not to switch on the reverse function of the electric motor inadvertently.



**Extra attention** is essential if a child is using the tricycle!

- **Never** leave a child alone with the tricycle without supervision!
- **Always** have the child wear a tricycle helmet! Make sure the helmet fits correctly!
- Have the child wear visible reflective clothing, so they are visible to other road users!
- Warn the child to ensure that no dangerous speed develops while driving downhill and entering tunnels. Brake on time.
- It is advisable to fit a flag onto the tricycle that is visible above the child.

### Load

The maximum load should not be exceeded. See the information in the technical data table in the '**Technical Specifications**' section of the user manual. By permitted load we mean the total load, including the load on the luggage rack (or in the basket).

Make sure that the permitted load on the luggage rack and in the basket is not exceeded. (**maximum** 20 kg). People may not be transported on the luggage rack or in the basket!

Be aware that a basket full of luggage can influence the steering considerably. No luggage that limits the use of the tricycle can be transported on the handlebars.

### Damaged or worn out parts

The replacement and repair of parts (frame, forks, light, brakes, drive mechanism and the handlebars) should **always** be performed by an authorised dealer. If not, the guarantee ceases to be valid and you will be personally responsible in the event of possible damage.



Specific safety parts should **always** be replaced by new parts!

## Adjustment of the tricycle

Before using the tricycle, adjust it to the measurements of the cyclist. This is of great importance, especially the saddle and the handlebars.



*If an optimal adjustment of the tricycle, as defined in the instructions, is not possible, you can contact your dealer for a fitting solution.*

The brakes are correctly adjusted and should only be adjusted by the dealer during periodic maintenance.



Take care that fingers and limbs do not get trapped while adjusting the tricycle.

### Saddle height (Husky, Mini, Midi, Maxi, Maxi Comfort, Victoria, Victor)

When the cyclist is sitting on the tricycle and can put a foot on the pedal in the lowest position, the saddle height is correct. Adjust the saddle height in such a way that the leg is stretched but relaxed in that position.

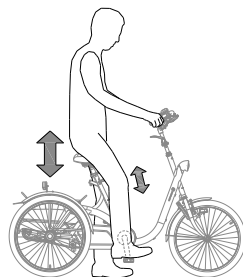

To adjust the saddle:

1. Slightly loosen the screw [A] using an Allen key.
2. Slide the saddle to the correct height.
3. Tighten the screw.

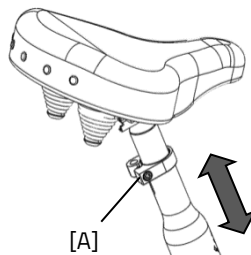

Do not pull out the saddle pin **further** than the marking. The tube will not go into the shank deep enough and will risk coming off. This can lead to serious injuries.





## Handlebars height (Husky, Mini, Midi, Maxi, Maxi Comfort, Viktoria, Viktor)

The height of the handlebars affects the comfort of the ride. It determines the pressure on the hands and the position of the back. You decide the most comfortable position yourself with some practice.

To adjust the handlebars:

1. Slightly loosen the screw by using an Allen key.
2. Slide the handlebars to the correct height and tighten the screw very firmly again.

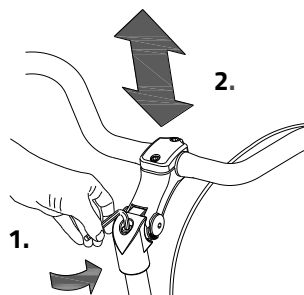

Do **not** pull out the handlebars **further** than the mark. Otherwise the tube will not be deep enough in the shaft and will risk coming off, which can lead to serious injuries.



## Position handlebars (Midi, Maxi, Maxi Comfort, Viktoria, Viktor)

You can tilt the handlebars. This influences the distance from the handlebars to the upper body. Determine your own most comfortable position by using the tricycle.

To tilt the handlebars:

1. Slightly loosen the screws [A] with an Allen key.
2. Put the handlebars in the desired position and then tighten the screws considerably.
3. Slightly loosen screw [B] with an Allen key, put the handlebars in the correct (horizontal) position and then tighten the screw again.

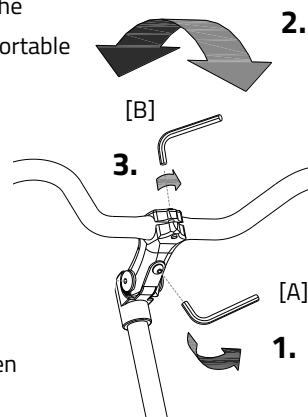

## Before the first use

### Parking brake

Always use the parking brake if you park the tricycle and leave it behind.

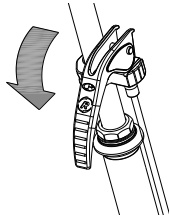

Block the tricycle with the hydro brake when passengers are getting on and off.

To operate the parking brake, squeeze the left brake [A] and secure the brake with the lever [B].

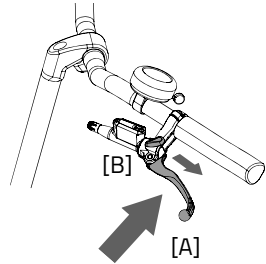

Always try to park the tricycle on a level surface. The tricycle may never be parked on a slope bigger than 6 degrees.

### Lighting

Normally, the lighting on your bike can be operated manually and set to different modes. However, if your bike is equipped with the Silent Elektro system, your lighting will automatically turn off when the electric system is activated. The controls of both the manually operated and centrally operated lighting is explained below.



*The Husky has no lighting. We recommend using the tricycle only in daylight.*

## Manually operated headlight

(Mini, Midi, Maxi, Maxi Comfort)

The headlight has a button with three different modes: ON – ON [50%] – OFF

Adjust the angle of the headlight to its correct position, when the centre of the light beam is about 10 metres in front of the bicycle.

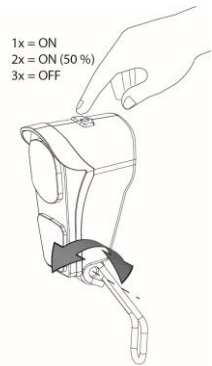

The headlight is powered by batteries. When the batteries are nearly empty, the LED light in the button of the headlight will turn red. Follow the steps to change the batteries of the headlight.

1. Open the headlight by pushing down the tab on the housing and simultaneously pulling the front of the light outward like shown.
2. Change the two alkaline batteries (2x AA).
3. Put the light back together by first pushing the top of the light back into the housing and then pushing the bottom of the light back over the tab of the housing.

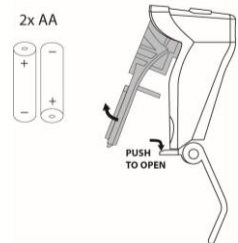

You can only operate the light while your bike is standing still to avoid dangerous situations and to avoid the chance of entrapment.

## Manually operated rear light

(Mini, Midi, Maxi, Maxi Comfort)

The rear light has three options which you can choose by pressing the button repeatedly: **On-Auto-Off.**

The setting is as follows:

*Press 1x: light is on*

*Press 2x: lighting is automatic*

*Press 3x: light is off*

With the "On" or "Off" mode, the rear light can be manually switched on and off.

With the "Automatic" mode the rear light automatically turns on and off with the help of light and movement sensors. When the tricycle stands still for a while, the light will automatically turn off.

The rear light works on batteries. When the batteries are almost empty, a red LED light on the top starts flashing. To replace the batteries, follow the next steps.

1. Dismantle the cover of the holder by pressing in the lip at the bottom of the light.

2. Replace the alkaline batteries

(1,5 V - 1500 mA) and assemble the cover.

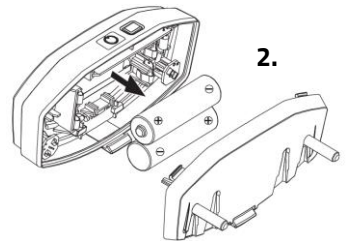
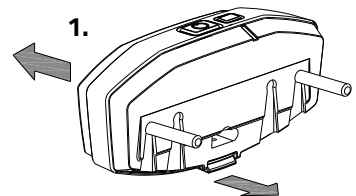
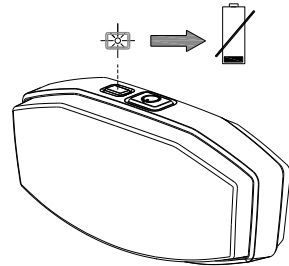
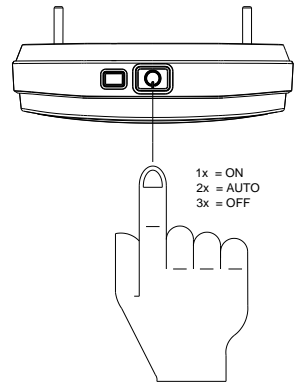

*Batteries cause environmental pollution.  
Follow the local regulations during disposal.*

## Centrally Operated Lighting

The bike has been equipped with centrally operated lighting, with the lighting being connected to the electric system. The lighting will turn on automatically when the electric system is activated.

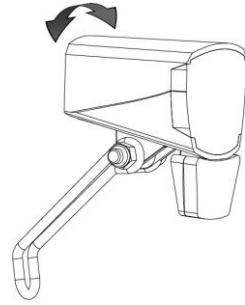

Adjust the angle of the headlight, so that the centre of the light beam is aimed about ten metres in front of the bike.

You can manually turn the lighting on and off by briefly pushing the on/off button on the display. When the electric system is turned off, the lighting will turn of automatically.



*Make sure there is always a battery on the bike when you are cycling after dark!*

Once the battery is nearly empty, the motor will no longer provide pedal support power assistance while cycling. The lighting will still be powered by leftover power.

## Gears

The tricycle has no gears or eight gears. The gear is operated by turning the grip.

**Do not use the pedals** when turning the grip.

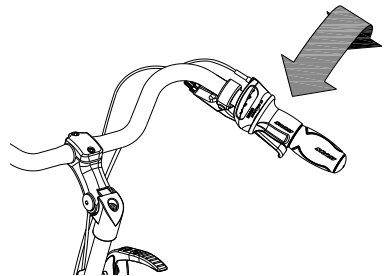

## Check before every ride:

- The brakes (including the parking brakes)
- The tyre pressure (recommended: 3 bar)
- The lights
- That all parts are fitted properly
- That the battery is adequately charged (depends on options)

Contact your dealer and stop using your tricycle as soon as you observe irregularities during the check!

As with all mechanical parts, the tricycle is subject to wear tear and high loading. If a component fails, it can lead to very dangerous situations. This can lead to damage or injuries to the user of the tricycle. Any form of cracks, scratching or change in colour in heavily loaded parts or a component indicates that the component must be replaced.

## Points of interest during cycling

After you have adjusted the tricycle to the measurements of the cyclist, you can start using the bike.



The tricycle gives a very different ride experience than a bicycle!

Practice, in particular, with bends and braking, because a tricycle can react contrary to what you would expect. It may happen that the back wheel comes off the ground on the inside when going round a bend. To avoid this the rider leans towards the inside of the bend with his body.

One of the brake levers (usually the right) operates the brake on the front wheel. This deserves special caution, as a forceful braking could block the front wheel, which could result in a fall. The driver should be familiar with controlled braking of the front wheel!



If there is an electric motor on a bike: you must train with the acceleration function and reverse functions. Be careful that the acceleration mode or reverse mode are not unintentionally started while using the bike. For example, at traffic lights the reverse function can accidentally be activated and the tricycle reverses.



High speeds in the bends, driving on rough ground, and sharp bends can lead to the tricycle **falling over!**



**Extra attention** is essential if a child is using the tricycle or a person with limited powers of perception is using the tricycle!

Before a child or an adult with limited powers of perception rides the tricycle independently for the first time, they should practice first under your supervision (or under the supervision of others).

Pay special attention to bends, because this can be a great source of danger. Also explain that the widest part of the tricycle is situated behind the driver. Let them practice passing several obstacles, to get a feel of the width of the tricycle!

Children or adults with limited powers of perception should **always** be made aware of the possible dangers of using a tricycle.

### **Important safety points for the cyclist**

- Be very careful during the first ride.
- When riding the tricycle hold both hands firmly on the handlebars and feet on the pedals.
- Test the riding style of the tricycle on rough ground at moderate speed. This way the cyclist learns how to react to unexpected movements of the tricycle and the handlebars during use.
- Explore how the tilting movements of the tricycle react to body posture. Tilt to the inside of the bend.
- Small obstacles should be cycled over with appropriate speed.
- Obstacles higher than five centimetre should be avoided.
- Ensure that no dangerous speed develops while driving downhill and entering tunnels. Brake on time.

## Electro system Silent

Item number: -2195

The Silent electrical system comprises 5 components: display, button unit, battery, motor and bottom bracket. How the first 3 parts are used is explained in this user manual.

### Operation of the display

The display provides you with cycling information, which will be explained in more detail later. The display is mounted onto the handlebars by means of a bracket. The display cannot and does not have to be removed when leaving the bike.

(1) On/off

This button switches the electrical system on.

(2) Bicycle lights

The lights on the bicycle switch on automatically when the electrical system is switched on. By pressing this button briefly, the lights can be switched off (and on).

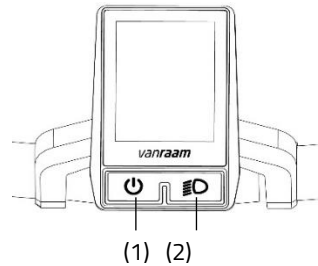

### Operation of the button unit

The button unit is mounted next to the handlebar grip. You use the button unit to operate the electrical system.



*The button unit can be mounted on the other side of the handlebars by your dealer.*

(3) Mode

By pressing this button briefly, you can switch between the different Screen modes.

(4) Plus - Increase pedal support power assistance

(5) Minus - Reduce pedal support power assistance

(6) starting aid

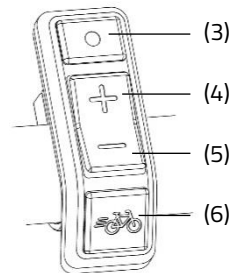



## Information screen

After the electrical system is powered up, the information screen is displayed. This screen displays real-time cycling information.



*The information screen will only work if you have switched on the electrical system.*

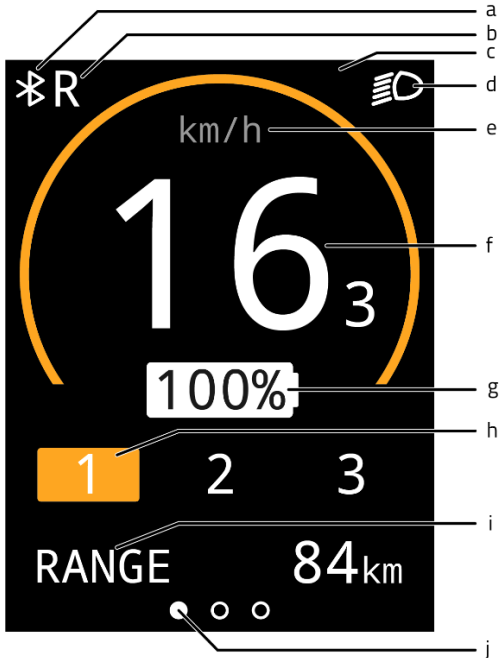

- (a) Bluetooth connection
- (b) Reverse function of (thumb) throttle activated
- (c) Notification field
- (d) Bicycle lights
- (e) Speed indicator
- (f) Speed
- (g) Battery charge percentage
- (h) Assistance mode
- (i) Screen modes
- (j) Screen mode orientation bar

## Screen modes

The screen mode (i) can be set by using the mode button (3) You can switch between the following 3 screen modes while cycling.

1. Radius of action [RANGE] (default display)  
This is the number of kilometres that can still be cycled with the remaining battery capacity in the active assistance mode.



*The range is assistance mode dependent and is an estimate, so the actual range may differ from the estimate. The range is dependent on several factors. Among others, the range is influenced by: battery capacity, amount of assistance, tyre pressure, ride speed, rider weight and load, and the environment.*

2. Trip distance [TRIP]  
This is the distance travelled since the trip odometer was last reset. By holding down the mode button for one second, the trip odometer can be reset to 0.



3. Total distance [TOTAL]  
This is the total distance travelled by the bicycle when the electrical system has been switched on.



## Settings screen





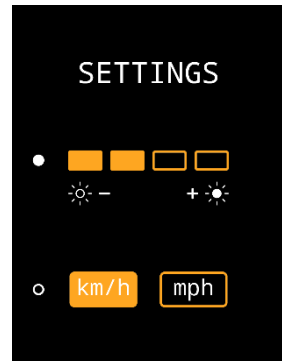

In the settings screen, the brightness of the display and the units of distance and speed can be changed.

To access the settings screen, the mode button (3) and the plus button (4) should be pressed down simultaneously for one second. Using the mode button (3), you can switch between the settings. The plus and minus buttons (4,5) are used to adjust the setting. To exit the setting screen, press and hold the mode button (3) for one second.



## Notifications

Several symbols can be displayed in the information screen. The symbols are explained below. More information on the notifications can be found in the chapter "**Possible Faults**".

-  The bicycle lights are activated
-  A Bluetooth connection is active
-  No communications with the battery
-  Reverse function of (thumb) throttle is activated
-  The temperature of the controller is too high
-  Voltage is too high
-  Fault

## Pedal support power assistance

The Silent electrical system provides assistance while cycling.

### Starting aid

With the starting aid, pedal assistance is activated up to a speed of 6 km/h, without having to pedal yourself. To do this, press and hold down the starting aid button (6). If the button is pressed again, the function is reactivated.

If you press the starting aid button while cycling, you will get a "boost". This boost will have the same maximum speed as the bike. The activated pedal assistance mode determines the degree of assistance of the starting aid and the "boost".

The starting aid button can be used for:

- Extra assistance when starting off (starting aid).
- Extra assistance when cycling uphill (boost).

## Assistance settings

The pedal assistance level can be set using assistance settings 1, 2 and 3. The assistance settings can be changed while cycling.

1. Low level of assistance, maximum range.



2. Average support, average range.



3. Maximum support, low range.



## Reverse pedalling

The reverse function is activated by pedalling backwards from a stationary position. After a few turns of the wheel, the motor is activated and the bicycle will reverse at the speed of 3 km/h for as long as it is pedalled backwards.



Do not let the electric motor's sudden behaviour take you by surprise. For example, if you wait at the traffic lights and pedal backwards just for fun, the reverse function will be activated and the bike will start riding backwards!

## Presets

A preset is a set of settings which sets the level of assistance. By loading a different preset, the level of assistance for all assistance settings can be adjusted. Presets can be changed by the dealer or through the Van Raam app.

## Van Raam E-Bike app

With the app, you can track various information and configure the assistance modes. (More information on this can be found in the chapter on the Van Raam E-Bike app).

## Charging the Battery

For the best performance and to prolong the life of the battery, we recommend that you charge the battery at home at room temperature.



Only use the charger if the temperature of the environment is between 0 and 35 degrees centigrade.

To charge the battery:

1. Unlock the battery by turning the key a quarter.
2. Push down and hold the lock. Then pull the battery out of the holder with your other hand.
3. Take the battery pack inside. **First** plug the charger into the socket. The green LED will light up. The charger is now on standby.
4. **Then** insert the charging connector of the charger into the charging point of the battery. The red LED will light up. The charger is now charging.



**Please note!** If the battery is not connected properly, the green LED will light up (standby mode). If the connection is poor, unplug the plug from the socket and clean the charger's connector with a dry cloth.

5. The charging time depends on the level of the battery. The charging time is approximately 2 hours with a 11,4 Ah/36 V battery and approximately 4.5 hours with a 23,5 Ah/36 V battery.
6. Once the battery is fully charged, the green LED will be solid. Now **first** remove the charging connector of the charger from the connector of the battery.
7. **Then** unplug the charger from the socket.
8. Put the battery back in the holder of the cycle and close the lock. If necessary, the battery can also be charged directly on the cycle.

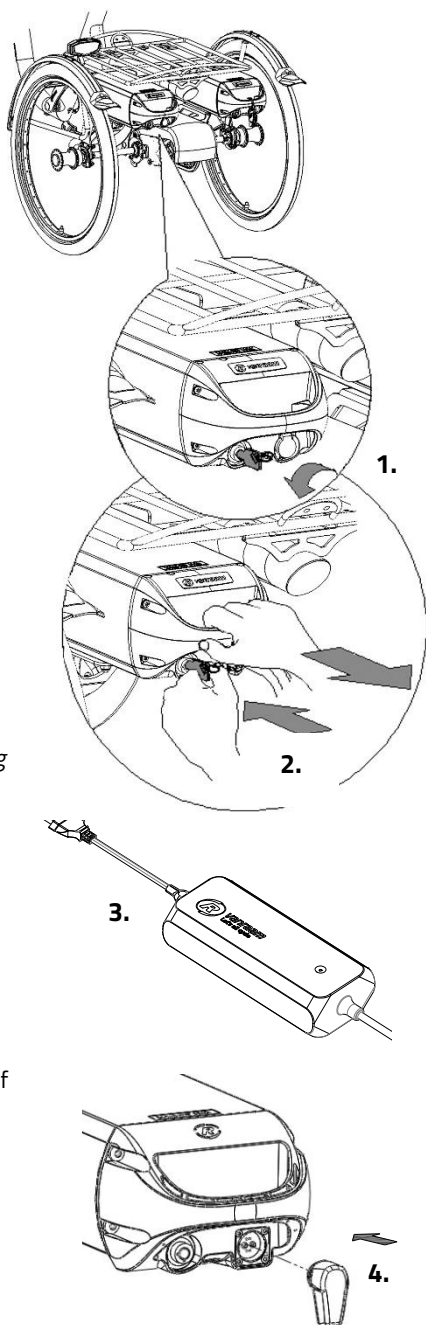

Charger:

LED indication	Status
Green	Standby / battery full
Red	Charging
Red, blinking	Safety: Polarity inversion; Short; Over temperature; Over power; Over voltage



It is better for the battery if it is charged regularly, rather than wait until it is completely drained. Never leave the bike with a drained battery!



Ensure that the battery is always pushed straight into the holder.

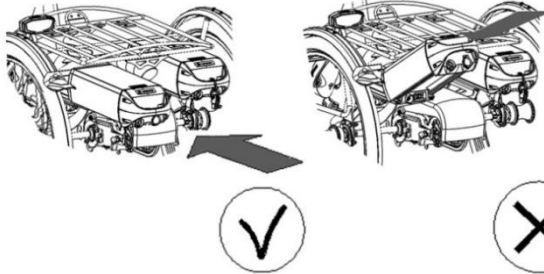

### Backup battery (optional)

The bike can be supplied with a second battery. When the first connected battery is empty, switch over to the second battery. One of the battery holders is connected to the system, you can recognize this one because of the cables.

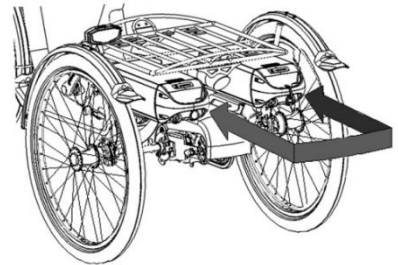

### Switchable battery pack (optional)

The bicycle may be fitted with a switchable battery pack. Once the connected battery is empty, you can swap the battery using a switch. This switch is located either under the seat, below the luggage rack or below one of the two batteries. Both batteries are connected to the system. If desired, you can leave the second battery to charge when you are using the other.

## Direction Indicator

The bike can be equipped with a direction indicator. To operate the direction indicators, press switch [A] on the handlebar to the left or right. When the direction indicator is active, a clicking sound can be heard. To deactivate the direction indicator, you need to set the button to the middle position. The direction indicator is powered by the battery of the Silent Electric System.

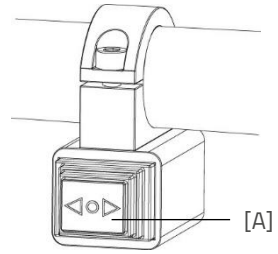

*Please note that the turn signal can only be activated when the bicycle's lighting is turned on.*

## Charger indicator light

The status of the charger is indicated by the coloured indicator light.

- If the indicator light is green, the charger is in standby mode or the battery is full.
- If the indicator light is red then the charger is charging the battery.
- ⊘ If the indicator light flashes red then the charger is in safety mode.

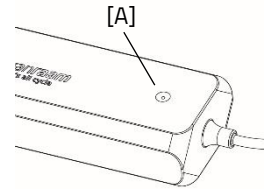

**Caution!** Unplug the charger from the power outlet.



Only use the charger when the ambient temperature is between 0 and 35 C.



It is better for the battery to be charged periodically instead of waiting until it is completely empty.

## Battery indicator lights

On the battery pack there is an LED indicator to check the battery charge status. The battery charge status can be read by briefly pressing the on/off button [A]. While the battery is being charged, the indicator shows the charging progress:

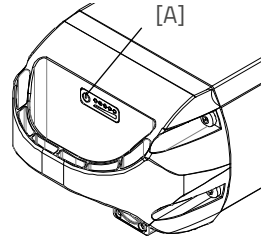

The battery is fully charged. When the battery is used, the number of green lamps will decrease.



If two green lamps are lit, the battery is 50% charged.



If only the left LED remains green, the battery is almost empty and needs to be recharged or replaced with a charged battery.



If the left LED starts blinking green, the battery is empty and the motor will not support cycling for much longer. However, the switchable lighting will still work after that.



Never put the bike away with an empty battery.



## Deep sleep battery mode

When the battery is almost empty and has not been used for a week, the battery will go into a "deep sleep mode". In this mode, the battery uses as little energy as possible, which extends the battery life.

When "deep sleep mode" is activated, the battery cannot be used. By pressing the on/off button [A] on the battery, the battery will be released from 'deep sleep mode' and can be used again. It is advisable to charge the battery before using it.

## Charging and maintenance of the battery pack

Important safety warning:

- To ensure the battery's optimal condition and capacity, we recommend charging it indoors at room temperature.
- Never put the bicycle away with an empty battery. We recommend charging the battery as soon as possible when it is empty. The best storage charging level for the battery is when the charge display shows three to five LED lights.
- In winter, check the battery charge every other month, recharge it if less than three LEDs light up.
- Preferably store and use the battery between 5 and 20 C, avoid higher and lower temperatures.
- Do not charge the battery in direct sunlight and make sure that the battery is not charged at a temperature lower than 5 C.
- Only use the charger in dry indoor areas, the charger is not allowed to get wet.
- Only use the supplied Van Raam battery and charger.
- The housing of the battery and the charger must not be opened. In case of any problems, please consult your dealer.
- A Van Raam battery is not allowed nor is it possible to recondition the battery due to safety reasons and incorrect functioning of the electrical system.
- Do not drop the battery as this can cause external and internal damage.
- If the bicycle malfunctions, the battery must be disconnected from the bicycle.



*Keep in mind that the bike provides less assistance at lower temperatures (0°C and below) and that the battery will drain more quickly. It also takes longer to charge at low temperatures.*



*Every battery drains over time. This process is called 'self-discharge'. A battery that is empty and not charged can undergo a deep discharge caused by self-discharge and become faulty as a result. The warranty is voided in the case of a deep discharge.*



*Keep in mind that every battery wears out over time. The wear and tear process of the battery is inevitable and depends on several factors such as use, the number of times to fully discharged and charged and the ambient temperature. Even if the battery is not used, its capacity will decrease. A worn-out battery can be used, but keep in mind that the range will be reduced.*

### **Possible faults**

- The system cannot be switched on:
  1. Check that the battery is attached properly.
  2. Check the status of the battery. If it is empty, charge the battery.
  3. If the above does not provide a solution, please contact your dealer.
- If a red LED flashes on the charger, unplug the charger from the power outlet and stop using the charger and battery. In this case, contact your dealer.

## Faults table

Fault symbol/ code	Description	Consequence/ course of action
All assistance modes are flashing	Temperature controller too high	System does provide assistance, motor power is reduced.
Thermometer (symbol) + all assistance modes are flashing.	Temperature controller too high	System does not provide assistance, let the controller cool down.
Battery with cross (symbol) + all assistance modes are flashing	No communications with the battery	System does provide assistance. Contact your dealer.
Lightning bolt (symbol) + assistance settings are turned off	Voltage too high	System does not provide assistance, voltage drops automatically when cycling speed is slower than maximum assistance speed.
Exclamation mark (symbol) Exclamation mark (symbol)	Voltage too low	System does not provide assistance, check the connection between controller and battery. Check how full the battery is.
	Controller communication error	System does not provide assistance. Contact your dealer.
Active assistance mode is flashing	Electrical current too high	System does not provide assistance. Contact your dealer.
Active assistance mode is flashing	Motor sensor fault	System does provide assistance. Contact your dealer.
All assistance settings are turned off.	The battery is almost empty.	Charge the battery

## Charging and maintenance of the battery pack

Important safety warning:

### Charger safety precautions

- Only charge Van Raam Li-Ion batteries with the supplied charger. Only connect the charger to a suitable wall socket (220–240 Volt AC 50–60 Hz). When the charger is not in use, disconnect it from the power outlet and the power plug from the battery.
- The charger may only be used by persons who have read the information in this manual and are familiar with the correct use of the charger. Keep the charger out of reach of children; they should not play with the charger.
- The charger is designed for use in a dust-free, dry and ventilated environment. Do not expose the battery to water, heat sources and direct sunlight. Keep the charger clean and dry.
- Do not charge batteries that feel hot. The battery may only be charged in places where the temperature is no higher than room temperature. Stop charging if the battery gets hotter than ( $> 40^{\circ}\text{C}$ ).

**Caution!** The charger can become warm during charging  $> 50^{\circ}\text{C}$ . First, carefully feel whether you can pick up the charger, this temperature can cause hypersensitivity or a startled reaction when it comes into contact with the skin.

- Do not use the charger if it is visibly damaged or modified. Do not repair the charger yourself! Please contact Van Raam. You are strictly prohibited from opening the charger yourself!
- Always keep an eye on the charger and battery while charging. When the battery is full, disconnect the power plug from power outlet and remove the power plug from the battery.

## Van Raam e-bike app

The Van Raam bicycle app is a free smartphone app that you can use while cycling on your electric Van Raam bicycle.

### What can you do with the Van Raam e-bike app?

- App can be used as a luxury bicycle computer
- Change bike settings
- Send SOS messages with GPS location to a number of your choice
- View information about the bike

### How does the Van Raam e-bike app work?

With the Van Raam e-bike app, a connection can be made with the display via Bluetooth connection. As soon as the display is ready to connect to the smartphone, the on/off button will briefly turn blue.

This app can be used as a luxury bicycle computer for Van Raam bicycles with pedal assistance and also contains many other extra functionalities. The dashboard on the app shows the current speed, total distance, trip meter, battery capacity and power consumption during the bike ride. For more cycling data, there is a details screen including average speed, maximum speed, total distance, power, battery voltage, pedaling power and pedaling frequency.

The Van Raam e-bike app can be downloaded free of charge from the **Google Play Store** or **Apple App Store**.

For more information about the Van Raam e-bike app, you can visit the Van Raam website: [www.vanraam.com](http://www.vanraam.com)



## Accessories

Depending on your order, you can use the accessories as described below. Extra accessories are available at your dealer.

### Push bar (Husky, Mini, Midi)

To fit the push bar:

1. Loosen the screw by using an Allen key.
2. Slide the push bar in the tube up to the stop. Then tighten the screw again very firmly by using the Allen key.

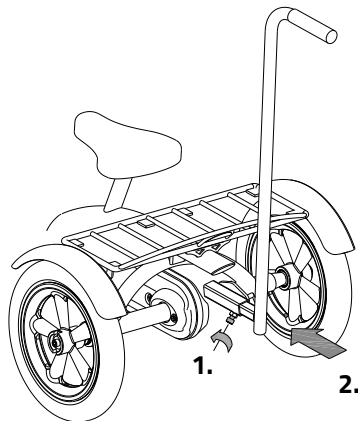

### Crank shortener

The crank shortener is fitted to the crank, as illustrated. The pedal can then be fitted into the crank shortener at two positions.

With the screw [A] the crank shortener should be aligned with the crank.

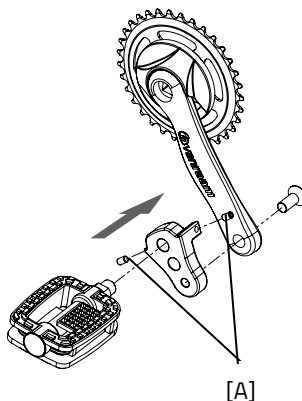

### Eccentric crank

The tricycle can be fitted with an eccentric crank on the left and/or right side. The illustration may differ from your crank, because it is custom made.

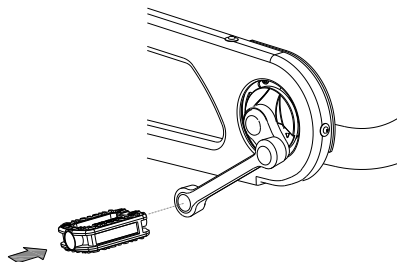

## Foot support

When using the foot support you can fix your foot by sliding the two straps [A] in the quick releases [B].

The quick release can be unlocked by pulling the lip to the rear. Now the strap can be pulled out.

You can cut the straps to size. The strap should retain a length of at least five centimetre.

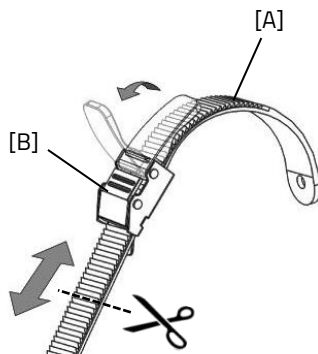

The position of the foot support on the pedal is adjustable in length. This allows you to pedal with the ball of your foot for better thrust.

1. Slightly loosen the four nuts with a socket wrench.
2. Slide the plate included the foot support forwards or backwards into the desired position. Then tighten the nuts again.

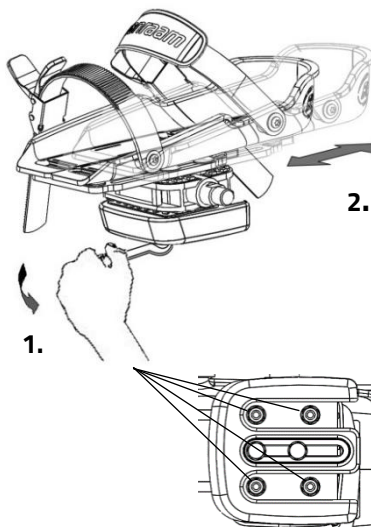

The foot support is also adjustable in width. Only the outer half of the foot support can be extended.

1. Slightly loosen the two screws with an Allen key.
2. Slide the adjustable half of the foot support to the desired position. Then tighten the screws again.

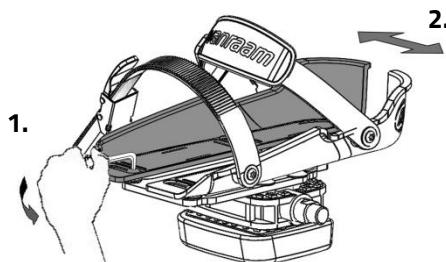

With the axel pedal extender the foot support can be extend further.



The small foot support (Fix20) is suitable for shoe sizes 22 up to size 36. The width of the range of this foot support is min. 6,5 cm to max. 9 cm. The large foot support (Fix25) is suitable from shoe size 37 up to size 48. The width of the range of this foot support is min. 8,5 cm to max. 13 cm.

The foot support returns to its neutral position when it is not used. The neutral position can be altered by shifting the balancing block.

1. Slightly loosen the two screws with a socket wrench.
2. Slide the balancing block to the desired position. Then tighten the screws again.

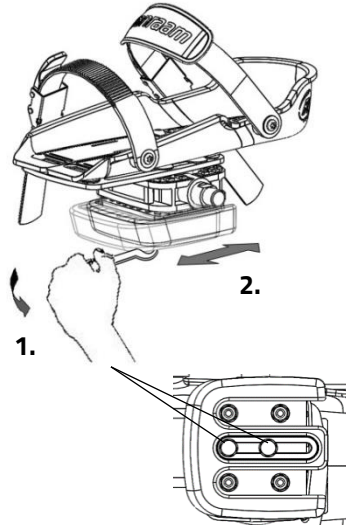

### Lower Leg Fixation

With the optional lower leg fixation, you can secure your lower leg. In order to set up the lower leg fixation:

1. Loosen the bolt [A] several turns using a nut spanner. Adjust the height of the lower leg fixation to the lower leg of the rider. Now tighten the bolt again.
2. Loosen the two nuts [B] several turns. The angle of the leg cup can now be adjusted. Rotate the leg cup in the correct position and retighten the nuts.
3. Use the Velcro to secure the lower leg.

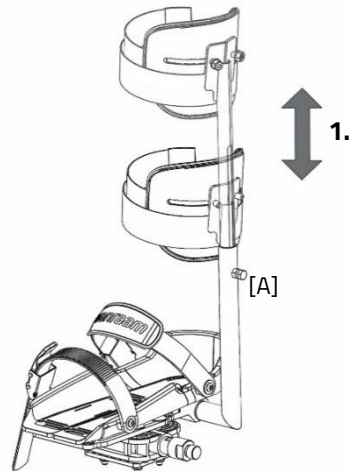
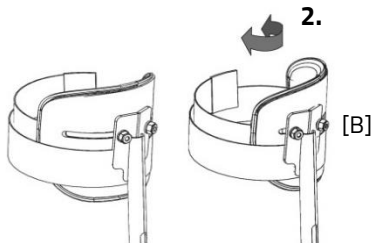



## Dividable frame

The tricycle can be divided into two parts. To divide the frame:

1. Use the parking brake.
2. Remove the grip from the handlebars. Push the pellets of the small spring [A] so that the grip can be removed from the handlebars.
3. (Electrical only) Disconnect the Velcro band so that you can reach the connectors.
4. (Electrical only) Disconnect the connectors. Pull the black connectors straight apart. Disassemble the metal connector.
5. Loosen the knob.
6. Remove the front part out of the coupling.

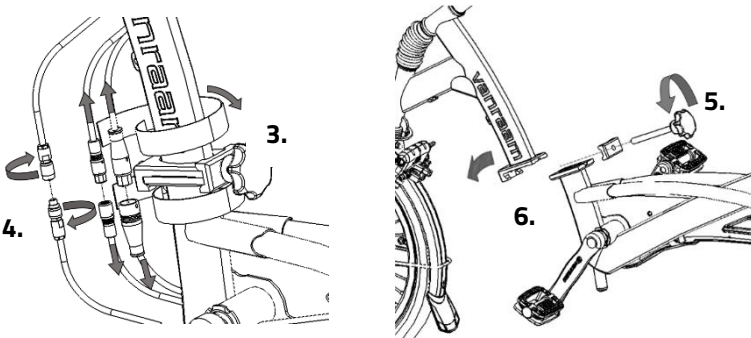
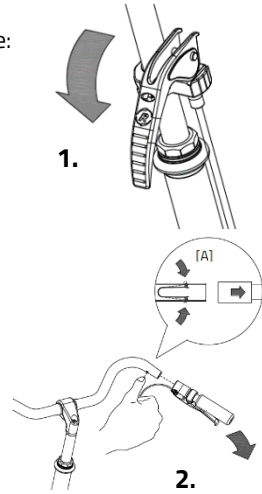

To assemble the tricycle again, follow these steps in reverse order. When connecting the cables, make sure that the arrows or cams are directly opposite to each other.

## Walking-stick holder

You can take two walking-sticks with you in the stick holder. Place the walking-stick in the holder at the bottom side [A] and then secure the stick in the fastening device [B] at the top side. Always fasten the walking-stick(s) with the Velcro band.

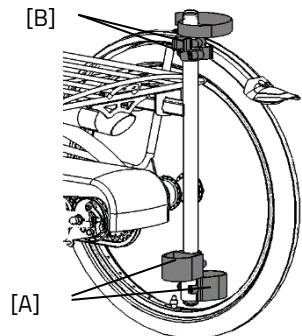

## Back support

Fit the back support under the saddle with the hexagon socket [A].

First adjust the right depth, by loosening four nuts [B], putting the back support in the right position and then tighten the nuts again.

Then adjust the right height by loosening the two nuts [C], sliding the support in the correct position and then tighten the nuts again.

The back support can be fitted with a belt [D]. Use the fastening device to open and close the belt.

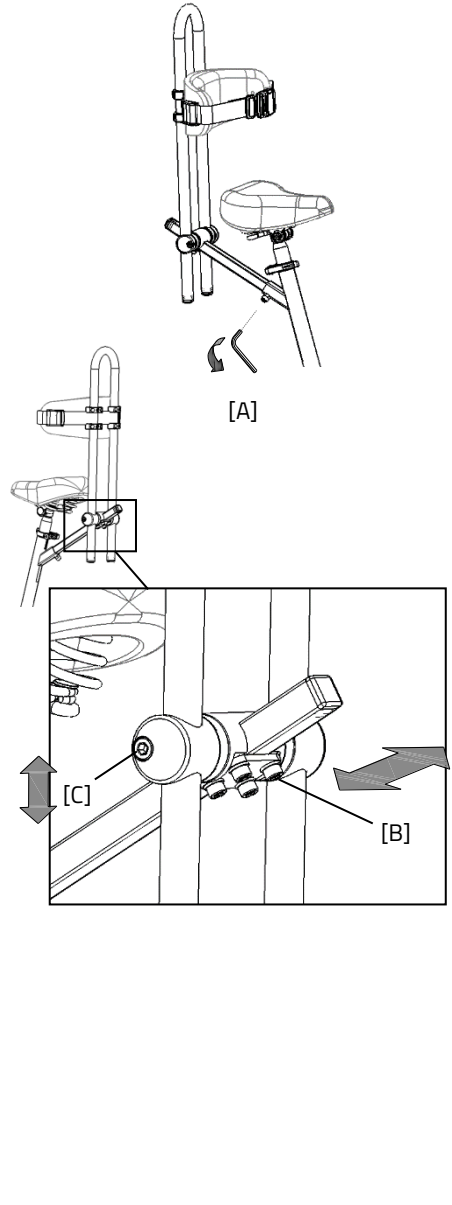

## Flashing light system

To use the flashing lights press the switch [A] to the left or right.

To turn off the indicators, move the switch to the centre position.

The lights work on a battery. To replace the batteries, turn the screw on the cap and take the orange cap [B] away. Then remove the PCB [C] from the holder. You can now replace the battery [D].

This is a 3-volt lithium battery, CR123A.



*Batteries cause environmental pollution. Follow the local regulations during disposal.*

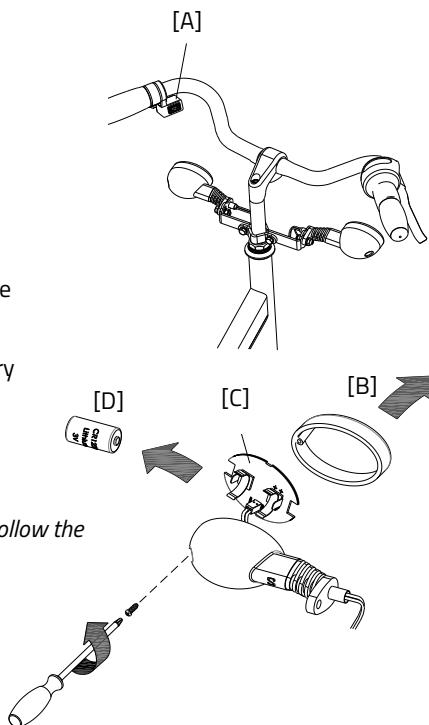

## Floating pedal

The floating pedal can be set to different positions. To do this, the hexagon bolt [A] must first be loosened a few turns with an Allen key. The floating pedal can then be adjusted to the desired height. Then re-tighten the bolt.



*The image may differ from the bicycle.*



*When rolling backwards and dismantling the bicycle, the floating pedal can kick back. Be aware that in this situation, the pedal may come into contact with the leg.*

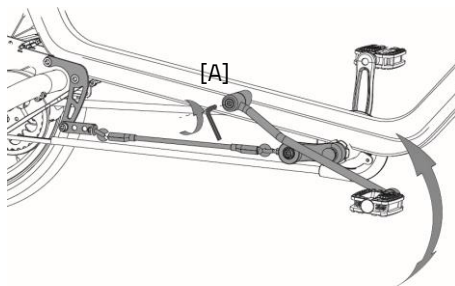

## Technical specifications

	Husky2	Mini3	Midi2	Maxi2	Maxi Comfort
<b>Length of inner leg (cm)</b>	35-47	47-59	66-80	80-95	67-82, 76-91 <sup>1</sup> , 85-100
<b>Frame height (cm)</b>	23	30	41	53	42, 51 <sup>1</sup> , 60
<b>Length (cm)</b>	98	136	168	180	194
<b>Width (cm)</b>	59	60	75	75	75
<b>Height (cm)</b>	68	88	108	124	118
<b>Weight (kg)</b>	appr. 11	appr.. 21	appr. 27	appr. 29	appr. 32
<b>Boarding height(cm)</b>	12	20	25	28	23
<b>Front wheel</b>	12.5"	16"	20"	22"	24"
<b>Back wheel</b>	12.5"	16"	22"	24"	24"
<b>Max. load luggage rack/ basket (kg)</b>	20	20	20	20	20
<b>Max. weight user (kg)</b>	65	65	90	120	120
<b>Brakes, front</b>	V brake	V brake	V brake	V brake	V brake
<b>Brakes, back</b>	Non or V brake	V brake or Back pedal brake	V brake or Back pedal brake	V brake or Back pedal brake	V brake or Back pedal brake

	Viktoria	Viktor
<b>Length of inner leg (cm)</b>	63-80	75-93
<b>Frame height (cm)</b>	41	50
<b>Length (cm)</b>	155	173
<b>Width (cm)</b>	80	89
<b>Height (cm)</b>	-	-
<b>Weight (kg)</b>	18	16
<b>Boarding height(cm)</b>	18"	20"
<b>Front wheel</b>	24"	26"
<b>Back wheel</b>	ca. 30 (bare)	ca. 30 (bare)
<b>Max. load luggage rack/ basket (kg)</b>	-	-
<b>Max. weight user (kg)</b>	125 <sup>2</sup>	125 <sup>2</sup>
<b>Brakes, front</b>	V brake	V brake
<b>Brakes, back</b>	V brake or Back pedal brake	V brake or Back pedal brake

<sup>1</sup> Standard, <sup>2</sup> Maximum user weight including luggage

## Maintenance and adjustments to be done by owner

Below you can find the instructions for maintenance and adjustments that you can do yourself on a regular basis, which will keep your tricycle in top condition.

### Cleaning

The frame of the tricycle can be cleaned with a damp cloth. For areas that are dirtier you can use a mild detergent. The wheels can be cleaned with a moist brush with plastic hairs (not a wire brush!). The saddle, the grips and the backrest can be cleaned with mild soap and water.



Do not use a pressure washer or a steam cleaner!

### The right lubricant

The chain should be cleaned and maintained at regular intervals (every three months approximately). Only use special chain grease or Teflon spray. This is the only way to make sure that the chain will run smoothly, will stay water resistant and will not rust.

1. Wipe the chain with a cloth.
2. Treat it with grease or spray.
3. Remove any excess lubricant with a rag.

Other parts should **not** be treated with a lubricant.

### Inspection of the tricycle

It is recommended that the tricycle has a yearly inspection carried out by the dealer to claim warranty. Please use the form "Form service, maintenance, modifications and warranty claims" in the back of this manual. After 200 kilometres or after a period of two months the tricycle should be inspected.

In the event of technical trouble or faults, the tricycle should be taken to the dealer for repairs **immediately**.

The replacing of safety-related components (especially frame, brakes, lighting, handlebars, front fork and actuation) should be performed by the dealer.

If you still decide you want to replace components yourself, you are responsible for damage or harm due to incorrectly fitted components. Only use **original** Van Raam spare parts, which you can buy at you dealer. If requested the dealer will make the necessary information on repair and maintenance available.

## **Repairs and maintenance to be done by dealer**

Check the brakes, the rims, lighting, the chain tension and the spokes. Also check the tyre tread depth. This should be at least one millimetre. Worn out tyres or possible faulty parts should be replaced. Also check the parking brake. With the parking brake pulled up, the tricycle should not ride away with the cyclist.

### **Checking the rim**

Due to the combined action of the brake and the rims, not only the brake lining but also the condition of the rim is important. For this reason the rim should be checked at regular intervals, for example when you inflate the tyres. The presence of fine cracks in the spoke punches or deformation of the rim when there is higher air pressure, indicate more serious wear and tear. In that case the rim should be replaced, because it can lead to loss of brake function or even a crack in the rim, which can lead to all kinds of dangerous consequences.

Repairs, maintenance and modifications should only be performed with original Van Raam parts.

## Adjustments to be done by dealer

### The correct tension of the chain

The chain should not be too tight. It should hang loose. Without effort you should be able to move the chain up and down, half a centimetre approximately.

### Adjusting chain tension (Husky, Mini, Midi, Maxi, Maxi Comfort)

To keep the chain tension correct, a special tensioning wheel is fitted on to the tricycle, as an integrated chain tensioner.

1. Slightly loosen the screw. Hold the nut at the back tight with a socket wrench to stop the screw from slipping.
2. Shift the tensioning wheel in such a way that the chain hangs loose, as described above.
3. Tighten the screw again.

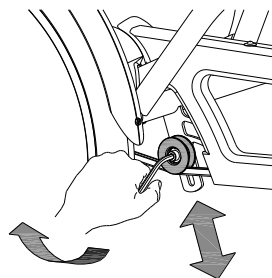

### Adjusting chain tension (Viktoria, Viktor)

To keep the chain tension correct, the back wheel axle is adjusted. Follow the instructions below:

1. Slightly loosen the nuts of the back wheel axle, so that the back wheel can move backwards and forwards.
2. Slide the back wheel backwards, so that the chain is hanging loose, as described earlier. Also slide the bracket [A].
3. At the same time make sure that the wheel is straight and positioned in the centre of the frame, as illustrated. Not to the left or to the right.

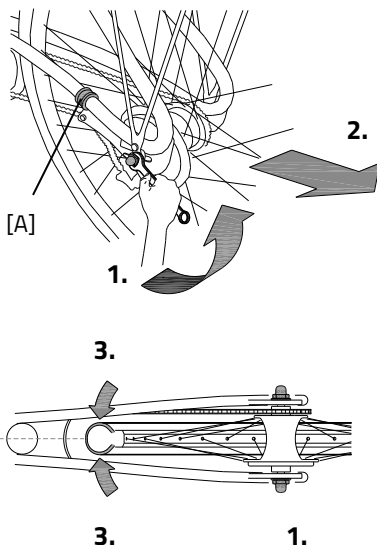

4. Slightly tighten the nuts.
5. Check whether the chain tension is correct and whether the wheel is straight and in the centre of the frame.
6. Tighten the nuts again.

## **Disposal**

If you want to dispose your tricycle, contact your dealer. You can also contact the local waste disposal company. They will dispose the tricycle according to the regulations of your town.

## **Recycling the Battery**

If your battery is defective or if you are no longer using it, you must have it recycled. Please contact your dealer. They are responsible for complying with the recycling obligation. Ask them about the conditions or view the rules regarding recycling in your place of residence/country.

## **Handover/sale to a new owner**

When you hand over your tricycle to a new owner it is important that you also hand over all necessary technical documentation and spare keys, so that the new owner can use the tricycle safely.



## Guarantee

The guarantee is valid for all faults in the product, which are proven to be caused by material or manufacturing error.

We give a guarantee of five years on the frame and the front fork. For all accessories and other parts (except wear parts) we provide a two year guarantee, as legally regulated. The guarantee only applies for normal use and maintenance of the tricycle, as described in this manual.

### **Beware!**

The guarantee as well as the product liability in general expires if the instructions stated in this manual are not followed. This is also the case if unauthorized maintenance is carried out or if technical changes or additions are made with non-original Van Raam parts without permission of Van Raam. The original CE certification will become nul-and-void if modifications are done by third parties. The absence of the certification can lead to problems in insuring your bike, and for any loss or incurred.

## Frame number

The frame number is printed on the sticker. This sticker is located on the frame, see the images below. At the Viktoria and Viktor the frame number is stamped in the frame, see the images below for the positions.

Example sticker:



Position sticker Husky, Mini, Midi, Maxi and Maxi Comfort:

Husky



On the frametube

Mini



On the back of the saddle

Midi



On the back of the saddle

Maxi



On the back of the saddle

Maxi Comfort



On the back of the saddle

Positions of frame number, stamped in a plate on the frame (Viktoria and Viktor):

Viktoria



In a plate in front of  
the hinge plate

Viktor



In a plate in front  
of the hinge

## Maintenance recommendation

A Van Raam bike often is subject to extensive use and must perform in all weather conditions. By correctly maintaining the bike, the lifecycle can be extended greatly. This maintenance can be done by a Van Raam dealer. In most cases, you can do the monthly and annual inspection yourself.

### Maintenance Overview:

What	One-person bike	Multi-person bike	Duration	By whom?
1 <sup>st</sup> service moment	3 months/300 km	3 months/200 km	15 min	Dealer
2 <sup>nd</sup> Service moment	6 months/1.000 km	6 months/500 km	15-30 min	Dealer
3 <sup>rd</sup> Service moment	12 months/2.000 km	12 months/1.000 km	30-90 min	Dealer
Monthly inspection*	Every month	Every month	15 min	User
Annual inspection*	Every 12 months	Every 12 months	60 min	User

\* This is advised to extend your bike's lifecycle. You can also have this done by your dealer.

#### Monthly inspection

15 minutes

Among them:

- Check and inflate the tyres
- Check the chain tension and grease if needed
- Tighten bolts/nuts where needed
- Check all lights
- Check the brakes
- Check all rotating parts and grease if needed
- Clean the bike

#### Annual inspection

60 minutes

Among them:

- Check and touch up the paintwork
- Check the wheels for any buckling
- Check the spoke tension
- Check the steering ball joints
- Check all lights
- Check the saddle clamp
- Check the placement of all electric components (E-Bikes only)

### **1<sup>st</sup> Service moment**

15-30 minutes

Among them:

- Check tyres and inflate
- Check the spoke tension
- Check the chain tension and grease
- Tighten any bolts and nuts if needed
- Check all brake cables and brake calipers
- Check the gears
- Check and grease all rotating parts
- Check all lights
- Clean the bike

### **2<sup>nd</sup> Service moment**

30-90 minutes

Among them: All points from service moment 1, and:

- Inspection of the pedals and bottom bracket
- Grease and tighten the lock
- Grease and tighten the steering stem
- Check the steering ball joints
- Run all tests in the dealer tool (E-Bike)

### **3<sup>rd</sup> Service moment**

60-120 minutes

Among them: All points from service moment 1, 2, and:

- Inspection of the paintwork
- Inspection of the frame/front fork
- Inspection of the seat cushions
- Inspect the functioning and sound of the motor/gear hub
- check reflectors for any damage
- Check all electric components on their placement (E-Bike)
- Run all tests in the dealer tool (E-Bike)

## Service plan

### 1<sup>st</sup> Service moment

- Yes/No
- Dealer:
- Mechanic:

Date:

Remarks:

.....

.....

.....

.....

### 2<sup>nd</sup> Service moment

- Yes/No
- Dealer:
- Mechanic:

Date:

Remarks:

.....

.....

.....

.....

### 3<sup>rd</sup> Service moment

- Yes/No
- Dealer:
- Mechanic:

Date:

Remarks:

.....

.....

.....

.....

## Annual inspection

Date	Dealer	Mechanic	Remarks









## Delivery and service form

Congratulations on your purchase of your Van Raam tricycle. This bike is produced with utmost care. To guarantee the quality as much as possible Van Raam produces the cycles according to the ISO 9001:2015 quality standards. Van Raam has been certified by DNV GL Business Assurance B.V.

You will especially enjoy your Van Raam bike when the bike is adjusted to your specifications and when the instructions in the user manual are followed. Pay special attention on the service intervals who specified in the manual of the bike.

To claim warranty and service you should always fill out this form, at least at delivery and service. This signed form declares that the end user had an instruction on the operation of the tricycle, that the tricycle is adjusted to the specifications of the end user and that the user manual is received.

### Fill out when the tricycle is delivered

Type Van Raam tricycle:	
Frame number:	
Key number:	
Delivered to:	
By dealer:	
Place:	
Date:	
Signature user bike:	Signature dealer:
When available, stamp dealer:	