

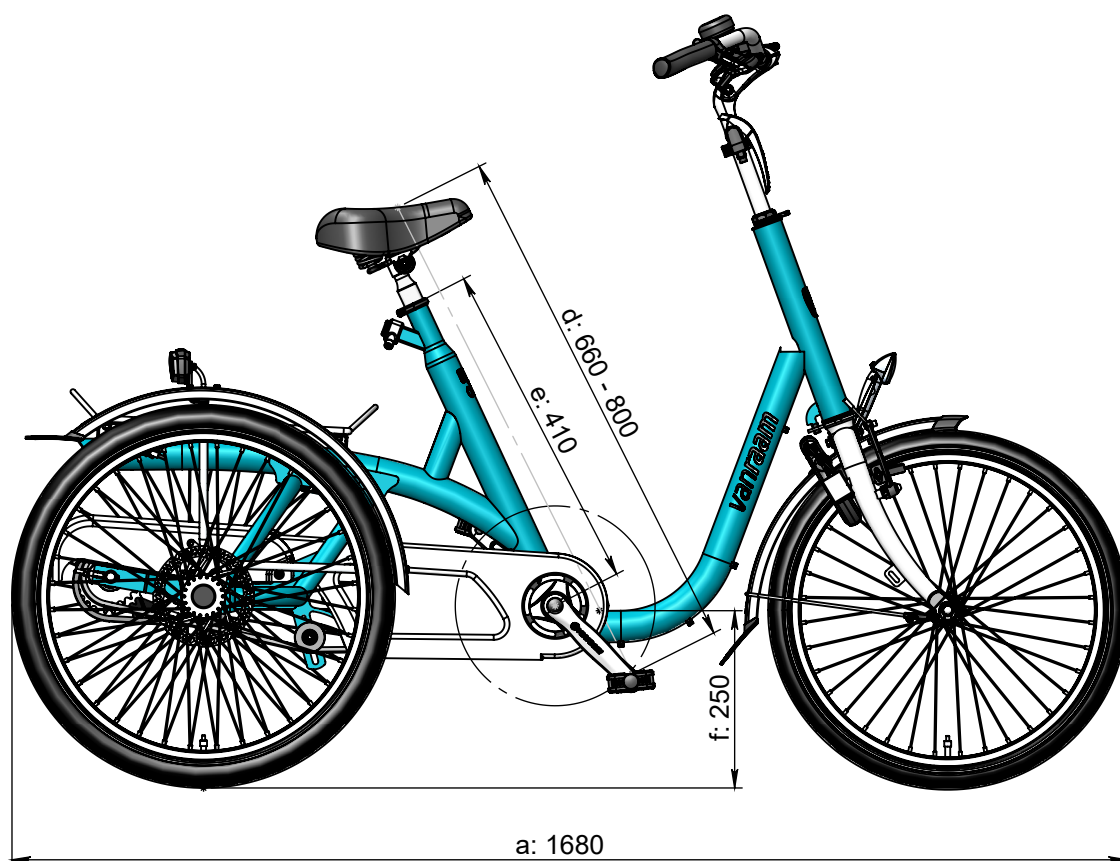

vanraam®
Let's all cycle

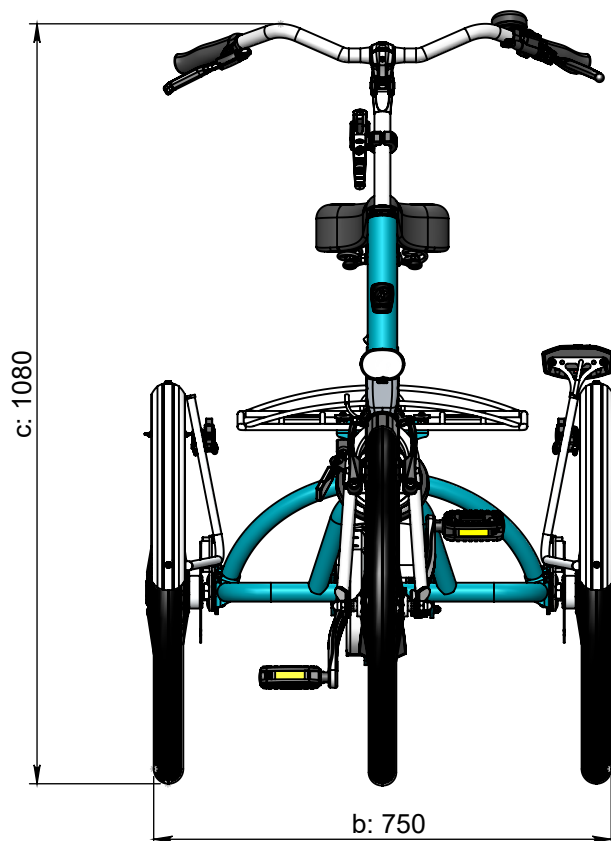

turning circle = 2,7 m
Standard frame size (400 mm)
a = maximum length 1680 mm
b = maximum width 750 mm
c = height 1080 mm
d = inseam 660 mm - 800 mm
e = frame height 400 mm
f = standover height 250 mm

Frame size (310 mm)
a = maximum length 1680 mm
b = maximum width 750 mm
c = height 1080 mm
d = inseam 570 mm - 710 mm
e = frame height 310 mm
f = standover height 250 mm

Frame size (490 mm)
a = maximum length 1680 mm
b = maximum width 750 mm
c = height 1080 mm
d = inseam 750 mm - 890 mm
e = frame height 490 mm
f = standover height 250 mm